

# BZTW SERIES

Hooded twin-wheel furniture castors. Housing and wheel made of black nylon, with pressed steel, zinc-plated fixings.

Available with top-plate, threaded-stem or stem-and-socket fixing.



40-60kg

Wheel diam or (mm) Swivel or Fixed Overall height (mm) Fitting Swivel radius (mm) Bearing type Black nylon body on black

41	S	52	A	40		BZTW40M8X15 40kg
			B	40		BZTW40M10X15 40kg
45	S	57	A	44		BZTW45M8X15 45kg
			B	44		BZTW45M10X15 45kg
50	S	61	A	50		BZTW50M8X15 50kg
			B	50		BZTW50M10X15 50kg
60	S	71	A	58		BZTW60M8X15 60kg
			B	58		BZTW60M10X15 60kg
40	S	52	C	40		BZTW404 40kg
45	S	57	C	44		BZTW454 45kg
50	S	61	C	50		BZTW504 50kg
60	S	71	C	58		BZTW604 60kg
41	S	52	D	40		BZTW402 40kg
45	S	57	D	44		BZTW452 45kg
50	S	61	D	50		BZTW502 50kg
60	S	71	D	58		BZTW602 60kg

Braked castors (wheelbrake only)

add to code: BR

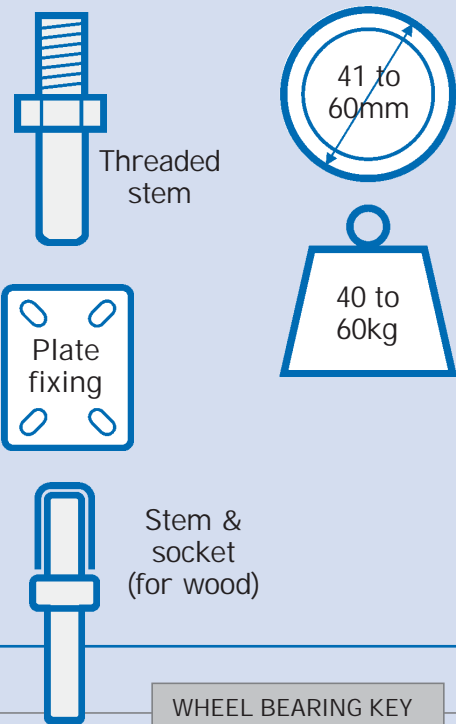

WHEEL BEARING KEY

Plain bore

BZTW SERIES INSTITUTIONAL

## FITTING TYPES AND DIMENSIONS (mm)

Type A

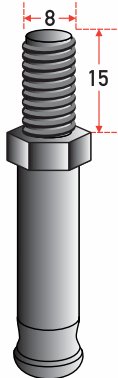

Type B

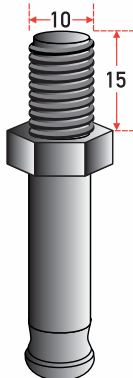

Type C

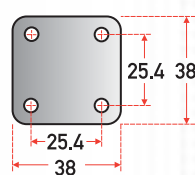

Type D (for wood)

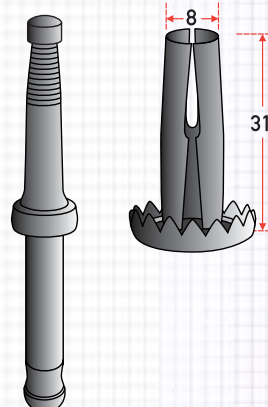



## BZD SERIES

Zinc-plated, pressed steel housing with double ball race in swivelhead.

Available with top plate or single bolthole fixing.

Wheel diam (mm) Swivel or Fixed Tread width (mm) Overall height (mm) Plate type Swivel radius (mm) Bearing type Grey rubber on grey polypropylene Black polypropylene Grey thermoplastic rubber on grey polypropylene

Wheel diam (mm)	Swivel or Fixed	Tread width (mm)	Overall height (mm)	Plate type	Swivel radius (mm)	Bearing type	Grey rubber on grey polypropylene	Black polypropylene	Grey thermoplastic rubber on grey polypropylene
40	S	17	54	D	43		-	BZD40PL 30kg	-
50	S	GR=18 PL=20	68	A	48 80*		BZD50GR 40kg	BZD50PL 40kg	BZD50VGR 40kg
							-	-	BZD50VGRBJ 40kg
75	S	GR=23 PL=25 VGR=24	97	B	68 83*		BZD75GR 70kg	BZD75PL 70kg	BZD75VGR 70kg
							-	-	BZD75VGRBJ 70kg
100	S	GR=27	132	C	88 100*		BZD100GR 90kg	-	-
							-	-	-
125	S	GR=27	156	C	103 103*		BZD125GR 100kg	-	-
							-	-	-

Braked castors (swivel and wheelbrakes)

add to code: **SWB**

Single bolthole castor (10mm)

add to code: **BH10**

\* Swivel radius when brakes are fitted

### WHEEL BEARING KEY

- Plain bore
- Ball journal

### AVAILABLE WHEEL TYPES (for full wheel specifications refer to pages indicated)



GR = p94

PL = p88

VGR = p95

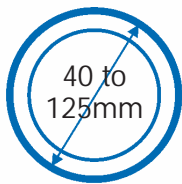

Bolt hole

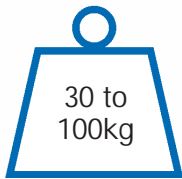

30 to 100kg

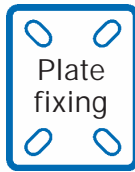

Plate fixing



30-100kg

## PLATE TYPES AND DIMENSIONS (mm)

Type A

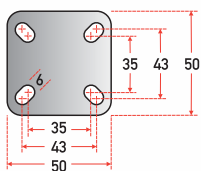

Type B

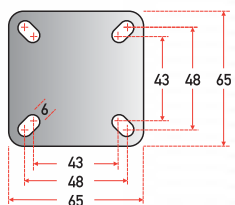

Type C

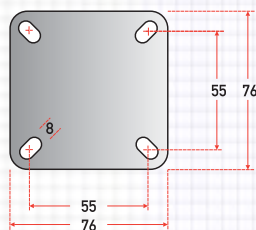

Type D

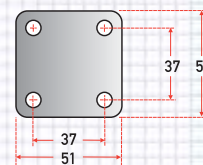

## Alternative fittings SPRING PLUGS

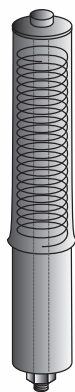

Description	Product code
<ul style="list-style-type: none"> <li>For mobile steps</li> <li>Fitted with a stepped plug 136mm long</li> <li>Fitted into a 25.4mm (1") O.D. outer</li> <li>Sleeve compresses on loading</li> <li>Spring weight 16kg</li> </ul>	BZDSPR16KG

## Single bolthole add to code: BH10

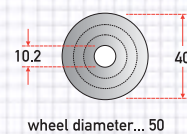

wheel diameter... 50

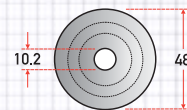

wheel diameter... 75

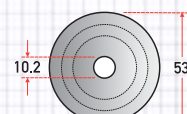

wheel diameters... 100 125

## SQUARE EXPANDERS

Tube section	Range for inside diameter of tube (mm)	Plug length (mm)	Plug material	Product code
Square	21 to 24	60	Rubber & nylon	BZAEXS21
		90		BZAEXS21XL
	26 to 29	60		BZAEXS26
		90		BZAEXS26XL
	31 to 34	60		BZAEXS31
		90		BZAEXS31XL

## ROUND EXPANDERS

Tube section	Range for inside diameter of tube (mm)	Plug length (mm)	Plug material	Product code
Round	19 to 22	60	Rubber & nylon	BZAEXR19
		90		BZAEXR19XL
	22 to 25	60		BZAEXR22
		90		BZAEXR22XL
	25 to 28	60		BZAEXR25
		90		BZAEXR25XL
	28 to 31	60		BZAEXR28
		90		BZAEXR28XL

For our full range of buffer wheels see page 125

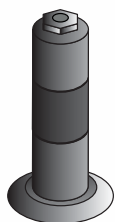
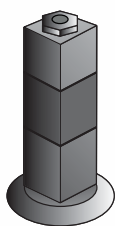

55-90kg







## 2BZD SERIES

Twin wheel, zinc-plated, pressed steel housing with sealed double ball race in swivelhead.

Available with top plate or single bolthole fixing.

Wheel diam or (mm)	Swivel or Fixed	Tread width (mm)	Overall height (mm)	Plate type	Swivel radius (mm)	Bearing type	Grey rubber on grey polypropylene	Black polypropylene	Grey thermoplastic rubber on grey polypropylene
--------------------	-----------------	------------------	---------------------	------------	--------------------	--------------	-----------------------------------	---------------------	---

50	S	GR=18 (x2) PL=17 (x2)	73	A	49		2BZD50GR 55kg	2BZD50PL 60kg	2BZD50VGR 55kg
					80*		-	-	2BZD50VGRBJ 55kg
75	S	GR=21 (x2) PL=25 (x2)	103	B	68		2BZD75GR 90kg	2BZD75PL 90kg	2BZD75VGR 90kg
					108*		-	-	2BZD75VGRBJ 90kg

Braked castors (swivel and wheelbrakes)

Single bolthole castor (10mm) 50mm

Single bolthole castor (12mm) 75mm



\* Swivel radius when brakes are fitted

add to code: **SWB**

add to code: **BH10**

add to code: **BH12**

### WHEEL BEARING KEY

	Plain bore
	Ball journal

### AVAILABLE WHEEL TYPES (for full wheel specifications refer to pages indicated)



GR = p94

PL = p88

VGR = p95

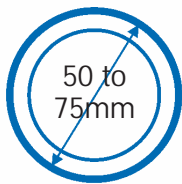

Bolt hole

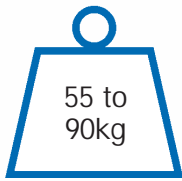

55 to 90kg

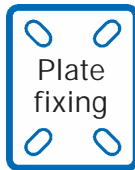

Plate fixing



55-90kg

## PLATE TYPES AND DIMENSIONS (mm)

### Type A

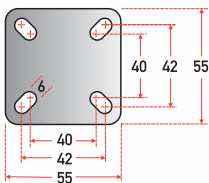

### Type B

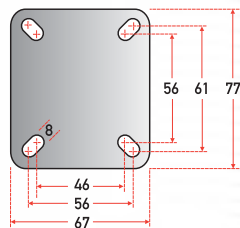

### Single bolthole

add to code: BH10

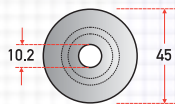

wheel diameter... 50

### Single bolthole

add to code: BH12

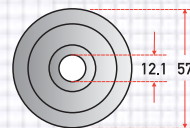

wheel diameter... 75

## Alternative fittings SPRING PLUGS

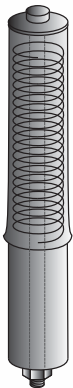

Description	Product code
<ul style="list-style-type: none"> <li>For mobile steps</li> <li>Fitted with a stepped plug 136mm long</li> <li>Fitted into a 25.4mm (1") O.D. outer</li> <li>Sleeve compresses on loading</li> <li>Spring weight 16kg</li> </ul>	BZDSPR16KG

## SQUARE EXPANDERS

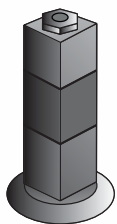

Tube section	Range for inside diameter of tube (mm)	Plug length (mm)	Plug material	Product code
Square	21 to 24	60	Rubber & nylon	BZAEXS21
		90		BZAEXS21XL
	26 to 29	60		BZAEXS26
		90		BZAEXS26XL
	31 to 34	60		BZAEXS31
		90		BZAEXS31XL

## ROUND EXPANDERS

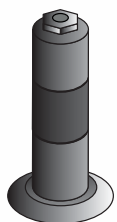

Tube section	Range for inside diameter of tube (mm)	Plug length (mm)	Plug material	Product code
Round	19 to 22	60	Rubber & nylon	BZAEXR19
		90		BZAEXR19XL
	22 to 25	60		BZAEXR22
		90		BZAEXR22XL
	25 to 28	60		BZAEXR25
		90		BZAEXR25XL
	28 to 31	60		BZAEXR28
		90		BZAEXR28XL

For our full range of buffer wheels see page 125

2BZD SERIES INSTITUTIONAL



40-80kg



## BZA /2BZA SERIES

Zinc-plated, pressed steel plate housing with double ball race in swivelhead.

Available with top plate or single bolthole fixing.

Wheel diam or (mm)	Swivel Fixed	Tread width (mm)	Overall height (mm)	Plate type	Swivel radius (mm)	Bearing type	Black Polypropylene	Grey Thermoplastic rubber on Grey Polypropylene
--------------------	--------------	------------------	---------------------	------------	--------------------	--------------	---------------------	---

50	S	VGR=18	72	A	49/82*	<input type="checkbox"/>	BZA50PLLP 40kg	BZA50VGRLP 40kg
	F	PL=22	72	A	-	<input type="checkbox"/>	BZAF50PLLP 40kg	BZAF50VGRLP 40kg
75	S	PL=22	101	A	63/92*	<input type="checkbox"/>	BZA75PL 50kg	BZA75VGR 50kg
	F	VGR=24	101	A	-	<input type="checkbox"/>	BZAF75PL 50kg	BZAF75VGR 50kg

### 2BZA SERIES

50	S	VGR=18 PL=20	72	A	49/82*	<input type="checkbox"/>	2BZA50PL 60kg	2BZA50VGR 60kg
75	S	VGR=24 PL=22	101	A	63/92*	<input type="checkbox"/>	2BZA75PL 80kg	2BZA75VGR 80kg

Braked castors (swivel and wheelbrakes)

add to code: **SWB**

Single bolthole castor (10mm)

add to code: **BH10**

\* Swivel radius when brakes are fitted

#### WHEEL BEARING KEY

Plain bore

AVAILABLE WHEEL TYPES (for full wheel specifications refer to pages indicated)



PL = p88

VGR = p95

BZA/2BZA SERIES INSTITUTIONAL

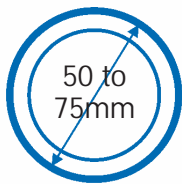

Bolt hole

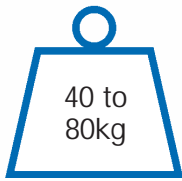

40 to 80kg

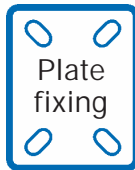
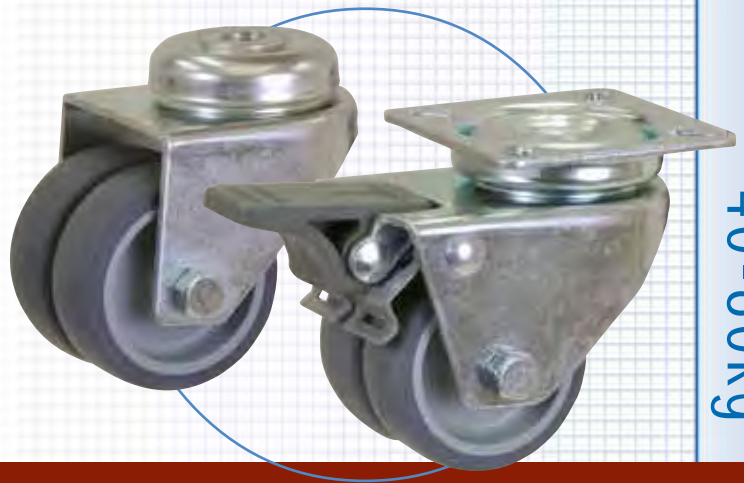

Plate fixing



40-80kg

## PLATE TYPES AND DIMENSIONS (mm)

### Type A

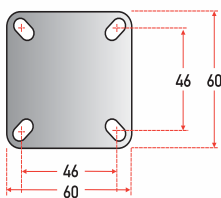

### Single bolthole

add to code: BH10

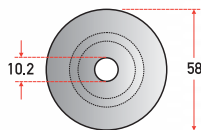

wheel diameters... 50 75

## Alternative fittings SQUARE EXPANDERS

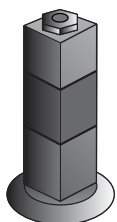

Tube section	Range for inside diameter of tube (mm)	Plug length (mm)	Plug material	Product code
Square	21 to 24	60	Rubber & nylon	BZAEXS21
		90		BZAEXS21XL
	26 to 29	60		BZAEXS26
		90		BZAEXS26XL
31 to 34	60	BZAEXS31		
	90	BZAEXS31XL		

## ROUND EXPANDERS

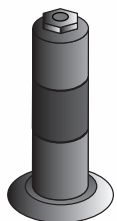

Tube section	Range for inside diameter of tube (mm)	Plug length (mm)	Plug material	Product code
Round	19 to 22	60	Rubber & nylon	BZAEXR19
		90		BZAEXR19XL
	22 to 25	60		BZAEXR22
		90		BZAEXR22XL
	25 to 28	60		BZAEXR25
		90		BZAEXR25XL
	28 to 31	60		BZAEXR28
		90		BZAEXR28XL

For our full range of buffer wheels see page 125

BZA/2BZA SERIES INSTITUTIONAL



70-90kg



## BZC SERIES

Zinc-plated, pressed steel housing with sealed double ball race in swivelhead.

Available with top plate or single bolthole fixing.

BZC SERIES INSTITUTIONAL

Wheel diam or (mm)	Swivel or Fixed	Tread width (mm)	Overall height (mm)	Plate type	Swivel radius (mm)	Bearing type	Grey Thermoplastic	Grey vulcanised Thermoplastic	Grey rubber
--------------------	-----------------	------------------	---------------------	------------	--------------------	--------------	--------------------	-------------------------------	-------------

80	S	30	113	A	70		BZCL80TPR 70kg	-	-
					109*		-	-	-
100	S	30	135	A	88		BZCL100TPR 80kg	BZCL100VGR 80kg	-
					118*		BZCL100TPRBJ 80kg	BZCL100VGRBJ 80kg	BZCL100GRBJ 80kg
100	S	30	135	B	88		BZC100TPR 80kg	BZC100VGR 80kg	-
					118*		BZC100TPRBJ 80kg	BZC100VGRBJ 80kg	BZC100GRBJ 80kg
125	S	30	160	A	104		BZCL125TPR 90kg	BZCL125VGR 90kg	-
					125*		BZCL125TPRBJ 90kg	BZCL125VGRBJ 90kg	BZCL125GRBJ 90kg
125	S	30	160	B	104		BZC125TPR 90kg	BZC125VGR 90kg	-
					125*		BZC125TPRBJ 90kg	BZC125VGRBJ 90kg	BZC125GRBJ 90kg

Braked castors (swivel and wheelbrakes)

add to code: **SWB**

Single bolthole castor (10mm)

add to code: **BH10**

Single bolthole castor (12mm)

add to code: **BH12**

\* Swivel radius when brakes are fitted

### WHEEL BEARING KEY

Plain bore  
 Ball journal

### AVAILABLE WHEEL TYPES (for full wheel specifications refer to pages indicated)

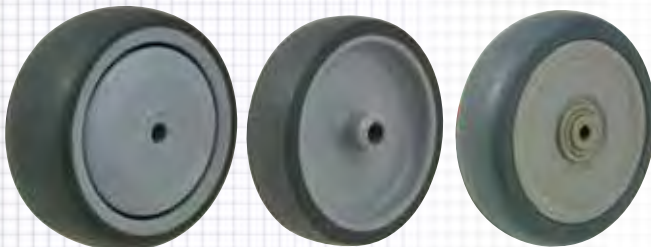

TPR = p95

VGR = p95

GR = p95

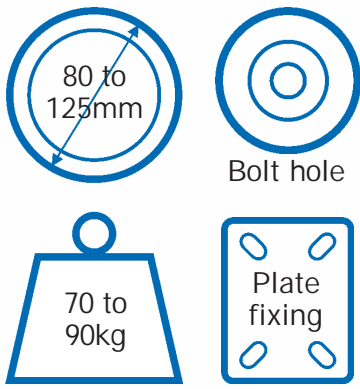

70-90kg

## PLATE TYPES AND DIMENSIONS (mm)

### Type A

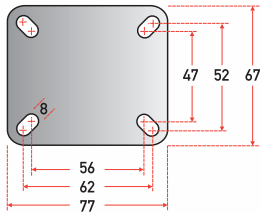

### Type B

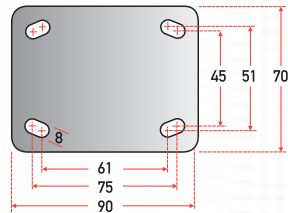

### Single bolthole add to code: BH10

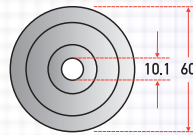

wheel diameters... 100 125

### Single bolthole add to code: BH12

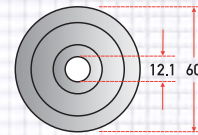

wheel diameters... 100 125

## Alternative fittings SPRING PLUGS

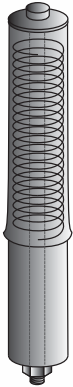

Description	Product code
<ul style="list-style-type: none"> <li>For mobile steps</li> <li>Fitted with a stepped plug 136mm long</li> <li>Fitted into a 25.4mm (1") O.D. outer</li> <li>Sleeve compresses on loading</li> <li>Spring weight 16kg</li> </ul>	BZDSPR16KG

## SQUARE EXPANDERS

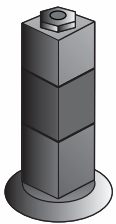

Tube section	Range for inside diameter of tube (mm)	Plug length (mm)	Plug material	Product code
Square	21 to 24	60	Rubber & nylon	BZAEXS21
		90		BZAEXS21XL
	26 to 29	60		BZAEXS26
		90		BZAEXS26XL
	31 to 34	60		BZAEXS31
		90		BZAEXS31XL

## ROUND EXPANDERS

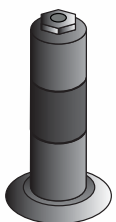

Tube section	Range for inside diameter of tube (mm)	Plug length (mm)	Plug material	Product code
Round	19 to 22	60	Rubber & nylon	BZAEXR19
		90		BZAEXR19XL
	22 to 25	60		BZAEXR22
		90		BZAEXR22XL
	25 to 28	60		BZAEXR25
		90		BZAEXR25XL
	28 to 31	60		BZAEXR28
		90		BZAEXR28XL

For our full range of buffer wheels see page 125

BZC SERIES INSTITUTIONAL



70-90kg

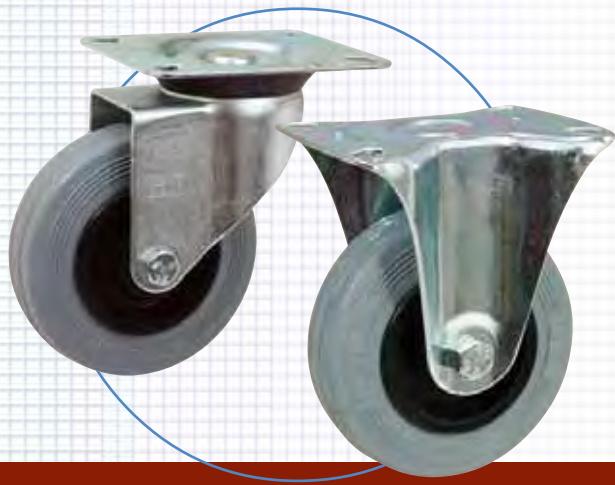

## BZBC SERIES

Zinc-plated, pressed steel housing with sealed double ball race in swivelhead.

Available with top plate or single bolthole fixing.

Wheel diam or (mm)	Swivel Fixed	Tread width (mm)	Overall height (mm)	Plate type	Swivel radius (mm)	Bearing type	White polypropylene	Black rubber on black polypropylene	Grey rubber on black polypropylene
--------------------	--------------	------------------	---------------------	------------	--------------------	--------------	---------------------	-------------------------------------	------------------------------------

Wheel diam or (mm)	Swivel Fixed	Tread width (mm)	Overall height (mm)	Plate type	Swivel radius (mm)	Bearing type	White polypropylene	Black rubber on black polypropylene	Grey rubber on black polypropylene
100	S	30	126	A	88	Plain bore	BZBC100PL 90kg	BZBC100PS 70kg	BZBC100GR 70kg
						Needle roller	BZBC100PLB 90kg	BZBC100PSB 70kg	BZBC100GRB 70kg
100	F	30	126	A	-	Plain bore	BZBCF100PL 90kg	BZBCF100PS 70kg	BZBCF100GR 70kg
						Needle roller	BZBCF100PLB 90kg	BZBCF100PSB 70kg	BZBCF100GRB 70kg
125	S	37.5 PL=32	154	A	100	Plain bore	BZBC125PL 90kg	BZBC125PS 90kg	BZBC125GR 90kg
						Needle roller	BZBC125PLB 90kg	BZBC125PSB 90kg	BZBC125GRB 90kg
125	F	37.5 PL=32	154	A	-	Plain bore	BZBCF125PL 90kg	BZBCF125PS 90kg	BZBCF125GR 90kg
						Needle roller	BZBCF125PLB 90kg	BZBCF125PSB 90kg	BZBCF125GRB 90kg

Braked castors (swivel and wheelbrakes)

add to code: **SWB**

Single bolthole castor (12mm)

add to code: **BH12**

\* Swivel radius when brakes are fitted

### WHEEL BEARING KEY

 Plain bore  
 Needle roller

### AVAILABLE WHEEL TYPES (for full wheel specifications refer to pages indicated)

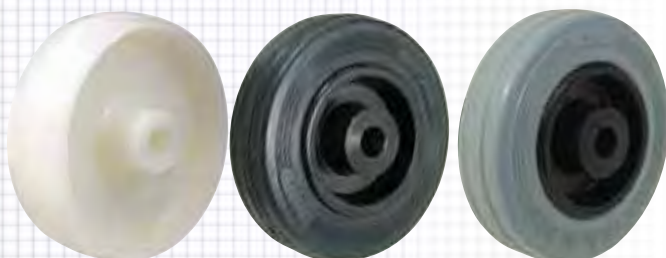

PL = p89

PS = p96

GR = p94

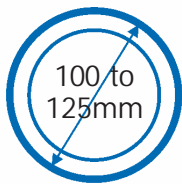

Bolt hole



70 to  
90kg



Plate  
fixing



70-90kg

## PLATE TYPES AND DIMENSIONS (mm)

### Type A

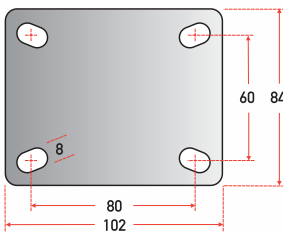

### Single bolthole

add to code: BH12

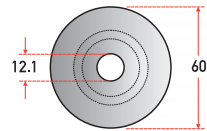

wheel diameters... 100 125

## Alternative fittings SPRING PLUGS



Description	Product code
<ul style="list-style-type: none"> <li>For mobile steps</li> <li>Fitted with a stepped plug 136mm long</li> <li>Fitted into a 25.4mm (1") O.D. outer</li> <li>Sleeve compresses on loading</li> <li>Spring weight 16kg</li> </ul>	BZDSPR16KG

## SQUARE EXPANDERS

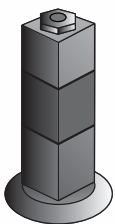

Tube section	Range for inside diameter of tube (mm)	Plug length (mm)	Plug material	Product code
Square	21 to 24	60	Rubber & nylon	BZAEXS21
		90		BZAEXS21XL
	26 to 29	60		BZAEXS26
		90		BZAEXS26XL
	31 to 34	60		BZAEXS31
		90		BZAEXS31XL

## ROUND EXPANDERS

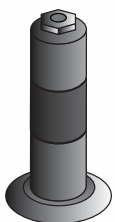

Tube section	Range for inside diameter of tube (mm)	Plug length (mm)	Plug material	Product code
Round	19 to 22	60	Rubber & nylon	BZAEXR19
		90		BZAEXR19XL
	22 to 25	60		BZAEXR22
		90		BZAEXR22XL
	25 to 28	60		BZAEXR25
		90		BZAEXR25XL
	28 to 31	60		BZAEXR28
		90		BZAEXR28XL

For our full range of buffer wheels see page 125

BZBC SERIES INSTITUTIONAL

